

ATEX LED HT-650 Zone 0 Headtorch

Zones: 0, 1, 2, 20, 21 and 22



Product Overview

The ATEX LED HT-650 Zone 0 Headtorch is the ideal high light output and long duration headtorch for hands free lighting, particularly where access is difficult, requiring climbing or crawling and are CE marked to the ATEX Directive and IECEx certified for safe use in Zones 0, 1 and 2 potentially explosive gas and Zones 20, 21 and 22 dust atmospheres. The approval code also covers all group II (industrial) gas apparatus groups, for potentially explosive gases up to T4 temperature class, and group I M1 mining applications.

The HT-650 weighs 180 grams including batteries and is constructed from robust, highly durable, high impact thermoplastic materials, which are chemical resistant and fitted with a shatterproof polycarbonate lens. The tilt adjustment mechanism allows the user to angle the light and the bespoke optics deliver a broad spot beam suitable for close up hands free tasks, and is designed for single-handed switching and water/dust tight to a minimum of IP66.

With a 'fitted for life' high power LED light source, the HT-650 has a powerful light output of up to 130 lumens with an optimum light duration of approximately 17 hours from a set of three AA alkaline cells. The use of primary cells makes it economical for personal lighting.

The ATEX LED HT-650 Zone 0 Headtorch is supplied fitted with an adjustable removable fabric head band allowing it to be comfortably worn directly on the head for extended periods and a set of 4 helmet clips to allow it to be securely attached to a hardhat. The HT-650 is also supplied with an easy clean inert silicone rubber strap, which grips to a hardhat.

NSN Codes

6230-99-2262040 - HT-650MOD

Features & Benefits

- ATEX Directive compliant
- IECEx Scheme certified
- Zone 0 explosive gas, vapour and mist and Zone 20 dust certified
- T4/T3 temperature class
- High Power LED light source
- Lightweight, ergonomic design
- Single handed switching
- Hands free operation
- IP66 water and dust tight
- Adjustable, removable headband
- Supplied with helmet clips for hard hat use
- Tilt adjustment for light direction

Certifications



1180

Technical Specification

Product Reference		HT-650
Product Description		ATEX LED HT-650 Headtorch
		Zone 0
Code	Industrial	I M1/II 1GD Ex ia op is I Ma/IIC T4/T3 Ga IP66 Ex ia op is IIIB T155°C Da
	Mining	I M1 Ex ia op is I Ma IP66
Type of Protection		'ia' Intrinsic Safety, 'op is' Optical Radiation
Area of Classification (Gas)		Zones 0, 1 and 2 - Gas groups IIA, IIB, IIC
Temp. Classification (Gas)		T4/T3
Ambient Temperature		-20°C to +40°C
Area of Classification (Dust)		Zones 20, 21 and 22 - Dust Groups IIIA, IIIB
Max Surface Temp. (Dust)		155°C
Certificate		Baseefa10ATEX0067X - IECEx BAS 10.0023X
Enclosure		High Impact Thermoplastic, Chemical Resistant
Lens		Shatterproof Polycarbonate
Beam Type		Broad Spot with Wide Angle Fringe Light
Light Source:	Type	High Power LED
	Output	Up to 130 lm
	Life	25,000+ hours (fitted for life)
Power Source:	Part Number	3 x HT-210 (LR6 Cells)
	Type	LR6 primary cells, to IEC 60086, Alkaline AA
	Volts	3 x 1.5v
Light Duration		Up to 17 hours
Ingress Protection		IP66
Weight (inc. cells)		0.180 Kg
NATO Codified Version		HT-650MOD - NATO Stock No: 6230-99-2262040

- All information has been gathered under laboratory conditions, the user must regard the values given as approximate.
- Changes may be made to the above specification without notification, details are available on request.

Product Dimensions

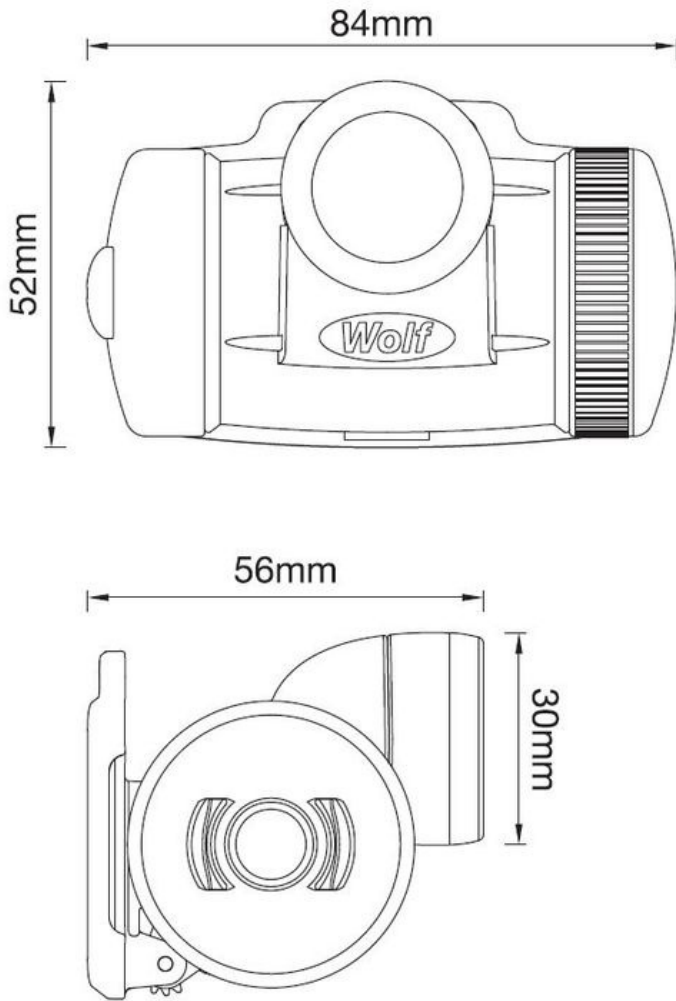

Light Output

High Power LED spot beam (approx 22°)
Peak luminous intensity at 1m **493 lux**, at 2.5m **67 lux**
Extra wide angle fringe beam (approx 100°)
Peak luminous intensity at 1m **32 lux**, at 2.5m **8 lux**

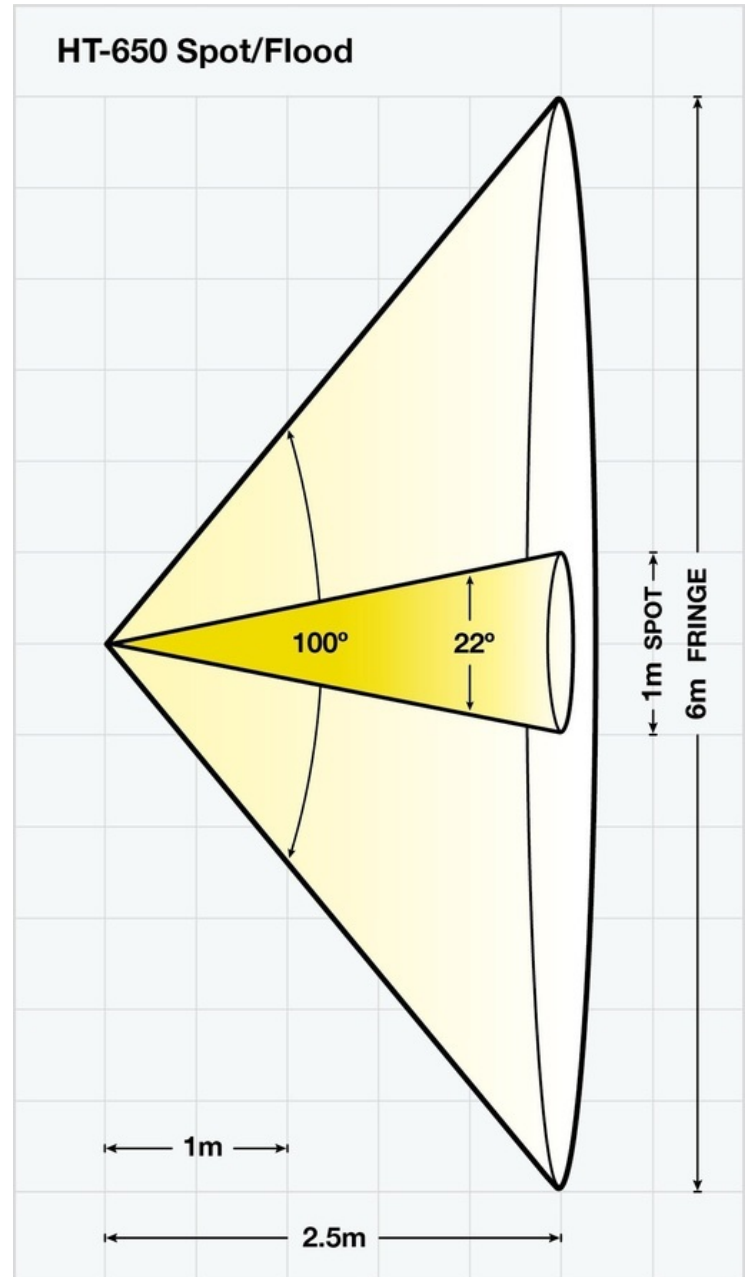

Version: SL052 DF504 Issue 3

Wolf[®]

Wolf Safety Lamp Company, Saxon Road Works, Sheffield, S8 0YA, UK

- T: +44 (0) 114 255 1051 • F: +44 (0) 114 255 7988
- E: info@wolfsafety.com • www.wolfsafety.com

